

USER MANUAL

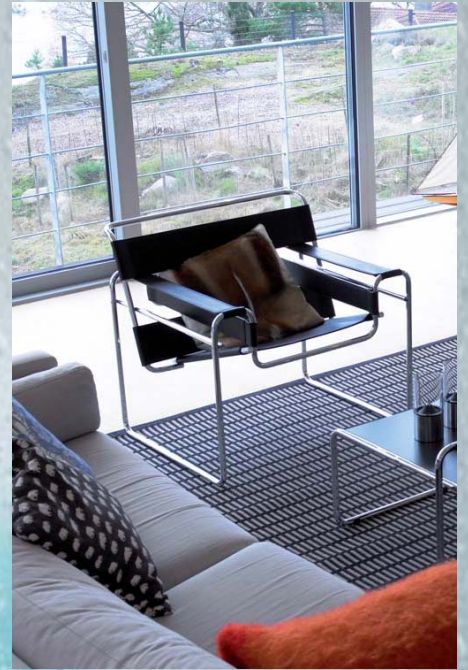

AIR SOURCE HEAT PUMP - ALL IN ONE- MODEL:

AWA-SS-6 AWA-SS-8 (230V/50Hz)

AWA-SS-8 AWA-SS-10

AWA-SS-12 AWA-SS-16 (3x400V/3/50Hz)



-Please read this operating manual before using the Heat Pump- TYDP

List of contents

1	Important Information	3
1.1	Safety Instructions.....	3
1.1.1	Installation and Maintenance.....	3
1.1.2	Modification of System Components.....	3
1.1.3	Safety Valve.....	3
1.2	Protective Measures.....	3
1.2.1	Preventing Corrosion	3
2	Unit Description	3
2.1	Heat Pump Principle.....	4
2.2	Auxiliary Heater – Electric Heating Element.....	5
2.3	Water Heater.....	5
2.4	Control Panel.....	6
2.4.1	Functions.....	7
3	Operating Instructions	7
3.1	General Information.....	7
3.1.1	Menu Navigation.....	7
3.1.1.1	Display of current operating mode	7
3.1.1.2	Symbols	8
3.1.2	Menus.....	9
3.1.2.1	Main Menu INFORMATION	9
3.1.2.2	Sub-Menu OPERATION	10
3.1.2.3	Sub-Menu HEAT CURVE.....	11
3.1.2.4	Sub-Menu TEMPERATURE.....	12
3.1.2.5	Sub-Menu INTEGRAL	12
3.1.2.6	Sub-Menu OPERATING TIME	15
3.1.2.7	Sub-Menu RESET	15
3.1.2.8	Sub-Menu MAN TEST	15
3.1.2.9	Sub-Menu DEFROST	16
3.1.2.10	Sub-Menu SETTING	18
3.1.2.11	Sub-Menu LANGUAGE	20
3.2	Adjustments to be made regularly.....	20
3.2.1	Heat Generation – General.....	20
3.2.2	Adjustment of the CURVE value.....	20
3.2.3	Adjustment of ROOM value	21
3.2.4	Adjustment of Part of the Heat Curve	23
3.2.5	Adjustment of the MIN and MAX value	24
3.2.6	Adjustment of the HEAT STOP value	25
3.2.7	Graph of recent changes in TEMPERATURE.....	25
3.3	Maximum Return Line Temperature.....	26
3.4	Warm Water Production.....	26
3.5	Regular Checks	26
3.5.1	Check of Operating Mode	26
3.5.2	Checking the Water Level of the Heating System	26
3.5.3	Checking the Safety Valve	27
3.5.4	In the Event of Leakage.....	27
4	Trouble shooting	28
4.1	Alarm Messages	28
5	Terminology and Abbreviations	29
6	Default Settings	30
7	References	30

1 Important Information

- * If the installation will be shut down during the winter months, the heating system should be emptied of water to avoid any damage due to freezing.(Call your Installation Contractor for help, see "References" on page 30).
- * The installation is practically maintenance free, but some monitoring will be required (see "Operating Instructions" on page 7).
- * Before making any adjustments of system parameters, first find out, what the consequences are in each case.
- * For all service work, please call your installation contractor.

1.1 Safety Instructions

1.1.1 Installation and Maintenance

Installation and commissioning as well as repairs and maintenance must be carried out by a qualified installation contractor (see "References" on page 30).

Any changes in the electrical installation must be undertaken by a qualified electrician (see "References" on page 30).

Service work on the refrigerant circuit must be carried out by a qualified refrigeration technician (see "References" on page 30).

Danger to Life!



1.1.2 Modification of System Components

The below components can only be modified by a qualified installation contractor:

- * Heat Pump Unit
- * Refrigerant, warm water and power lines
- * Safety Valve

No structural changes may be made to the installation that might affect the operational reliability of the heat pump.

1.1.3 Safety Valve

The following safety instructions must be observed in regard of the safety valve of the heating circuit and the overflow pipe:

- * Never close the connection between safety valve and overflow pipe.
- * When heated, water tends to expand which causes some water to be let out through the overflow pipe. This water may be hot! The overflow pipe should therefore discharge into a floor drain placed so that nobody can get hurt.

1.2 Protective Measures

1.2.1 Preventing Corrosion

To eliminate any risks of corrosion, the use of all kinds of aerosol should be avoided in the proximity of the heat pump. In particular, avoid the following:

- * Solvents
- * Detergents containing chlorine
- * Paint
- * Glue

2 Unit Description

In order to get the best results from the climate system AWA-SS series you should read through the section For the System manager in these Installation and Maintenance instructions.

AWA-SS series is a climate system for heating houses and apartment buildings as well as industrial properties. Air can be used as the heat exchange source.

AWA-SS series is a complete heating installation for heating and hot water.

It is fitted with new design on the market to be developed specifically for heat pumps. A new evaporator enables a new and improved circulation system for the refrigerant. The heat pump has an integrated 150 or 200 litre water tank and

an immersion heater. The Tap Water Stratification system improves the efficiency of heat transfer by keeping the water in distinct thermal layers in the water tank.

The unit is fitted with a regulating computer, which is controlled over a graphic display unit.

Heat is distributed throughout the house over a hydronic heating system referred to as low temperature system with a maximal water temperature to radiators (Feed line temperature) of 65°C. Most of the heating demand is taken care of by the heat pump (compressor unit), the auxiliary heater being started only when demands exceed available heat pump capacity.

AWA-SS series consists of five main components:

a. Heat Pump Unit

Rotary or Scroll-compressor

Stainless steel heat exchangers

Circulation pumps for heating systems

Valves and safety equipment for refrigerant system, complete with necessary electric components

b. Water Heater

150 or 200 litre

Lined with copper sheet against corrosion or made of stainless steel

Maintenance free as no anode is used

c. Reversing Valve

Opening or closing the connection to water heater according to operating mode: heating or warm water production

d. Auxiliary Heater

3 / 6 / 9 kW electric heating element

Three-step capacity control

Fitted on supply line

Delivers back-up heat in case of great heat demand that exceeds heat pump capacity

Starts automatically, provided operating mode "AUTO" has been selected

e. Regulating Equipment

The regulating system controls heat pump components (compressor, circulation pumps, auxiliary heater and reversing valve). Based on data received from sensors, it starts or stops heat pump operation and determines whether heating or warm water shall be produced. The system consists of:

Control computer with graphic display unit

Temperature sensors (outside air, room, feed line, return line)

2.1 Heat Pump Principle

A heat pump can exploit the energy contained in natural heat sources. Or, to put it differently, the heat pump "collects" heat energy from the heat source. This makes the heat pump a very environmentally friendly and economically sound alternative for space heating.

- a. The Outdoor unit is used as the heat pump's evaporator. Here the heat energy of the Outdoor Unit causes the refrigerant, circulating through the evaporator, to boil and turn into a gas – it evaporates.
- b. The refrigerant, having absorbed heat energy, is circulated to the compressor where pressure and temperature are raised.
- c. The refrigerant continues to the condenser. When condensing, it releases heat energy to the heat carrier, circulating through the condenser. The temperature of the refrigerant sinks, and it returns to its liquid state.
- d. The heat energy released is carried by the heating circuit to water heater and radiator or floor heating systems.
- e. At last the refrigerant is led through the expansion valve, where its pressure is reduced, and then continues to the evaporator. The process is restarted.

The heat pump has two separate liquid circuits

Refrigerant circuit – circulating inside the heat pump. Through evaporation, compression and condensation it absorbs energy from the outdoor unit and releases it to the heat carrier. The refrigerant is chlorine-free.

Heating circuit – water transporting heat energy to the heating system (radiators/floor coils) and the water heater.

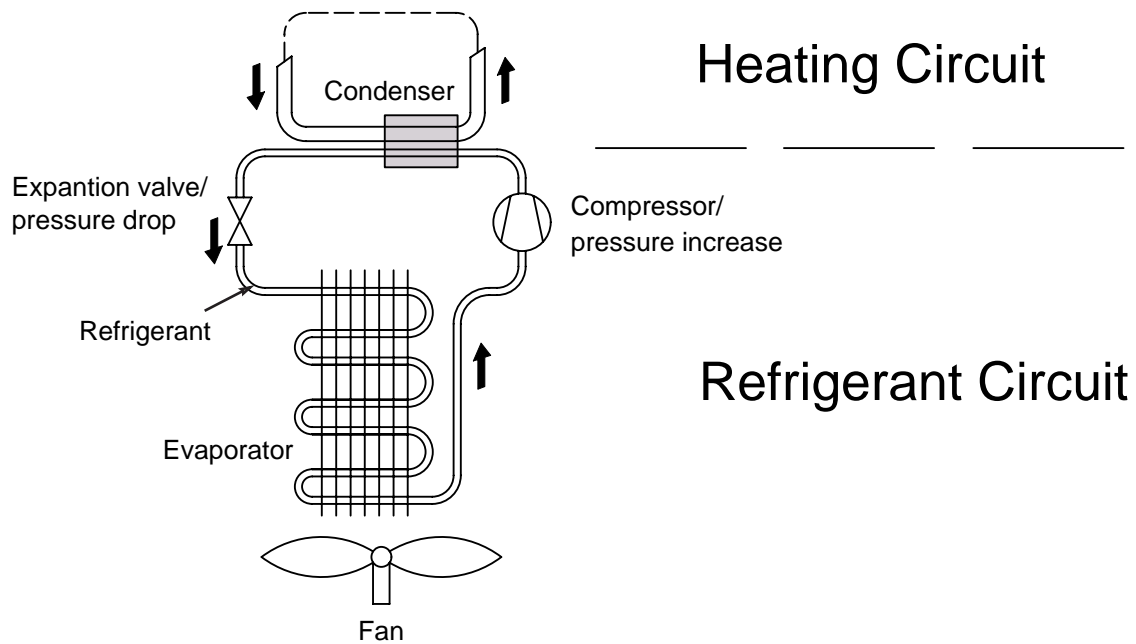

2.2 Auxiliary Heater – Electric Heating Element

The auxiliary heater – an electric heating element fitted on the supply line – has three capacity steps:

Step 1 = 3 kW

Step 2 = 6 kW

Step 3 = 9 kW

2.3 Water Heater

AWA-SS series comes with a built-in water heater holding 150 or 200 litres. The temperature of the water sent to the water heater is controlled by the regulating pressure switch and cannot be adjusted. Warm water production is stopped when the regulating pressure switch reaches its operating pressure, which corresponds to about 50-55°C warm water temperature. At regular intervals the water in the water heater will be heated to as much as 65°C as a preventive measure against bacteria. The preset interval is 14 days. For more information, please refer to "Warm Water Production" on page 26.

AWA-SS

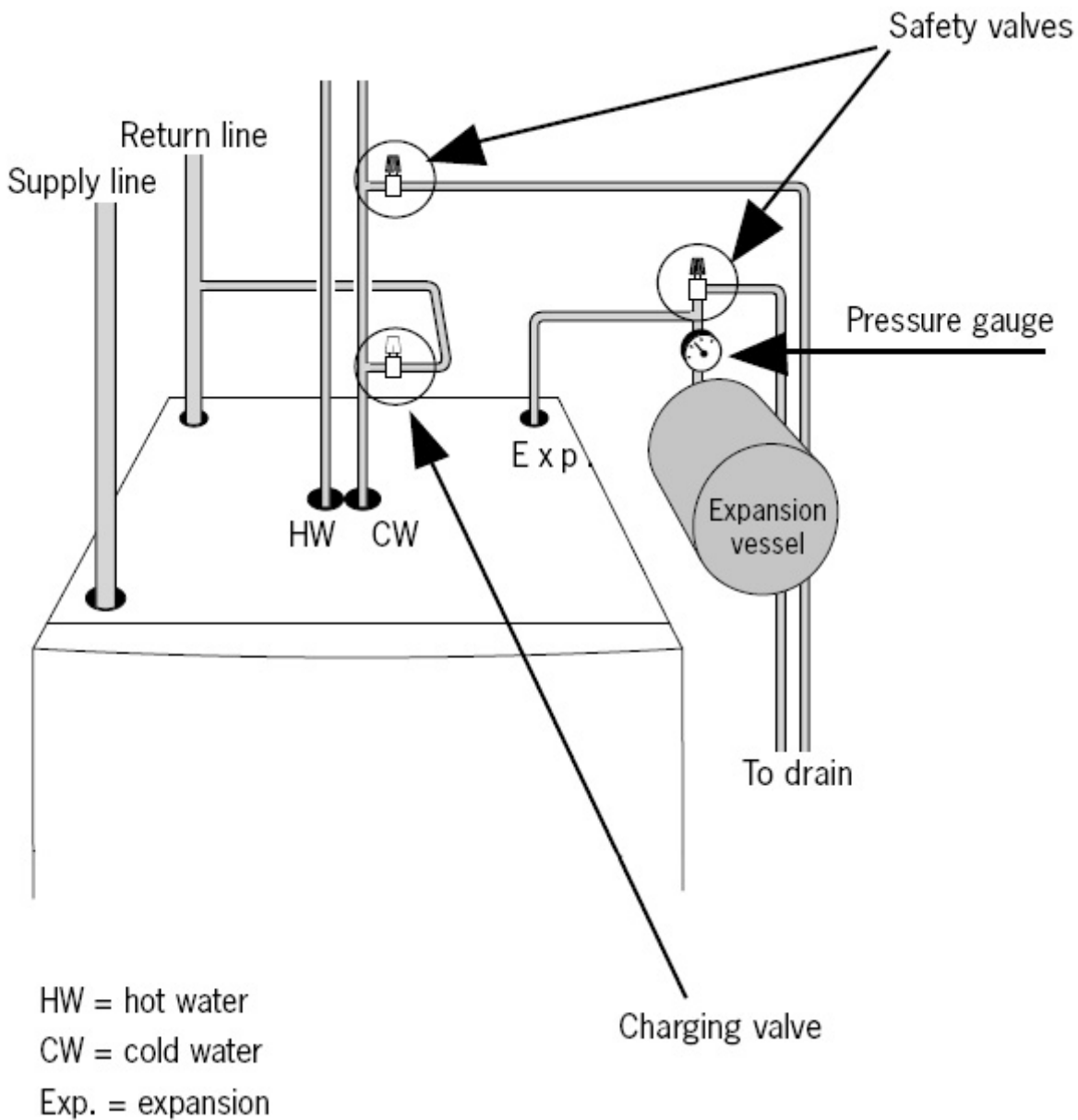

2.4 Control Panel

The control panel of AWA-SS series features a graphic display, five control buttons.

Beside the control panel you will find the User's Manual, a short description of how to increase and reduce room temperature, and a label with name and phone number of dealer.

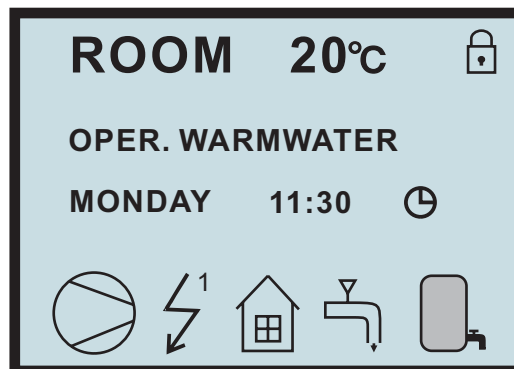

Graphic display

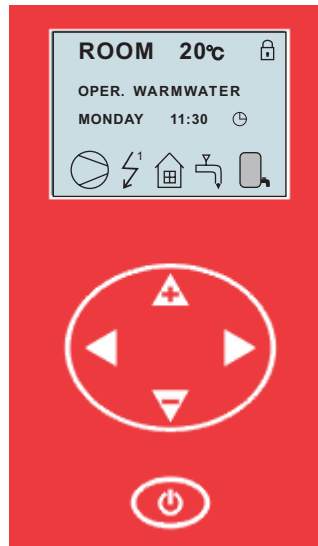

Control Buttons (influence key)

2.4.1 Functions

The control computer is operated with the help of a user friendly menu system that is displayed on the control panel. There is a main menu and several sub-menus accessible from the main menu. The menus are described in detail further down.

To be able to select the desired menu and increase or reduce preset values, you will use the five buttons.

- One button pointing upwards marked with a up arrow
- One button pointing downwards marked with a down arrow
- One button pointing to the right marked with a right arrow
- One button pointing to the left marked with a left arrow
- One button pointing to the ON/OFF

When display at the interface, press button Right for 5 seconds for locking the display (will show a symbol of lock.) All buttons are not available after lock is active, until press button Right for 5 seconds to open the lock; if the lock is active and then power supply cut off, the lock will be open after power supply resume.

3 Operating Instructions

3.1 General Information

3.1.1 Menu Navigation

The right-hand button on the control panel is used to open the desired menu.

The left-hand button is used to return to the previous menu.

The up and down buttons are used to navigate between the parameters of a menu.

A cursor (arrow) on the left-hand side of the display indicates which menu can be opened.

The up and down buttons are also used if you wish to increase or reduce a preset value.

3.1.1.1 Display of current operating mode

During normal operation, the following information will be displayed:

- Desired (preset) room temperature
- Date / time / timer
- Whether there is a heating demand or not. If there is, there will also be symbols telling which heat source is working, heat pump or auxiliary heater or both (see "Symbols").
- Which operating mode has been selected.

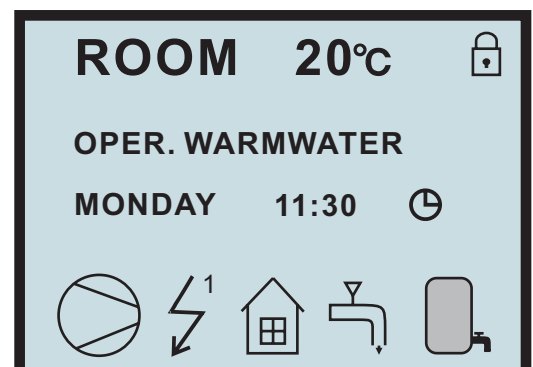

Symbols

For you to know at a glance the actual operating mode of the heat pump, each of the following symbols will be shown in the lower part of the display depending on which part of the unit is working:



1. The heat pump is running.



2. The auxiliary heater is activated.



3. There is a room heating demand.



4. Warm water is being produced.



5. Indicates the status of warm water production. If the symbol is empty, warm water temperature is under the setting temperature. It does not mean that there is no water in the water tank. The tank is always full.



6. If the symbol is full, warm water temperature reached to the setting temperature.

3.1.2 Menus

3.1.2.1 Main Menu INFORMATION

To open the main menu INFORMATION, press the right- or left-hand button once.

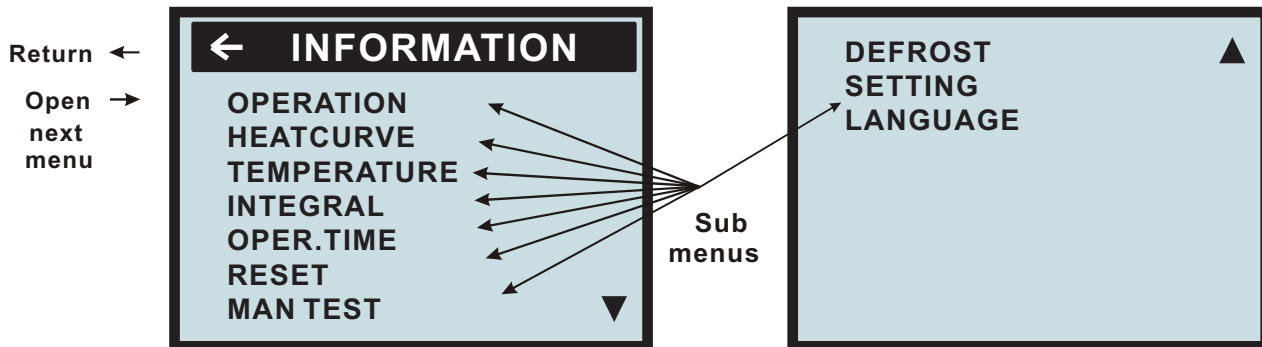

To select the desired sub-menu, use the up or down button. Open the menu by pressing the right-hand button once. To return to the main menu, press the left-hand button once.

OPERATION

Running mode: Room heating 1, Room heating 2, Water tank heating.

HEATCRVE

The setting of this submenu will affect the room temperature; CURVE is program that adjusts feed water temperature according outdoor ambient temperature, factory setting is ambient temperature 0°C as feed water temperature 40°C, that is CURVE =40; the value of CURVE is adjustable from 22°C to 56°C. How to change the slope—two points decide one beeline, point one is (0,40), the other point could be (18,24), the point (18,24) is not changing when changing the slope, because factory setting is that heat pump stops when outdoor ambient temperature is 18°C, so the feed water temperature should be 24°C.

TEMPERATURE

Temperature items setting.

INTEGRAL

Integral is a program to set the startup time and distance between compressor and electrical heater, to set stop conditions of compressor and electrical heater. This program is depends on the "feed water temperature degeneratiaon" and Time.

OPER.TIME

To calculate how much time have been running by compressor, electrical heater.

RESET

Return to factory settings: press button Right to go back all factory settings.

MAN TEST

Engineer testing

DEFROST

To set the defrosting manually or automatic defrosting setting

SETTING

To set Daytime, Time, electrical heater timing, water tank heating timing, whole unit timing, Emergency mode 1, Emergency mode 2, auxiliary electrical heater.

3.1.2.2 Sub-Menu OPERATION

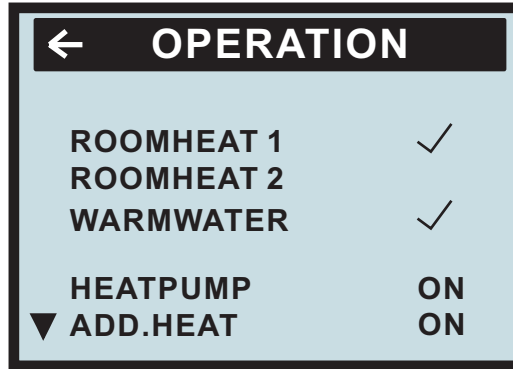

ROOMHEAT1 :

After select mode ROOMHEAT 1, the heat curve is that feed water temperature determined by outdoor ambient temperature. At the time, ROOMHEAT2 be of no effect.

ROOMHEAT2 :

After select ROOMHEAT 2, feed water temperature is adjustable from 10 to 65°C, factory setting is 45°C. At the time, the system is controlled by time and flow temperature, ROOMHEAT 1 is of no effect (not affected by ambient temperature)

WARMWATER+ROOMHEAT1 (ROOMHEAT2) :

Auto mode: select (✓) water tank heating and room heating at the same time, enter Auto mode. After enter this mode, water tank heating has the priority (compressor restart when in water tank heating must follow program 'CMPDI TEMP'). When water tank get to setting temperature, three -way valve will change its direction to room heating automatically. If the water tank temperature decrease, three-way valve's direction will go back to water tank heating.

HEATPUMP (ON or OFF)

ON : select ON, compressor is running normally.

OFF : select OFF, only switch off compressor , the others are running normally.

ADD.HEAT (ON or OFF)

ON : select ON, electrical heater is running normally.

OFF : select OFF, only switch off electrical heater , the others are running normally.

If you wish to change operating mode:

- Open the main menu INFORMATION by pressing the right-hand button once. You will find the cursor at the sub-menu named OPERATION.
- Open the OPERATION menu by pressing the right-hand button once. You will find the cursor at the previously selected operating mode.
- Select the desired mode by pressing either the "up" or "down" button.

Return to the main menu by pressing the left-hand button twice.

3.1.2.3 Sub-Menu HEAT CURVE

This menu is used for making adjustments that affect the room temperature. For more information, please refer to "Adjustments to be made regularly" on page 20.

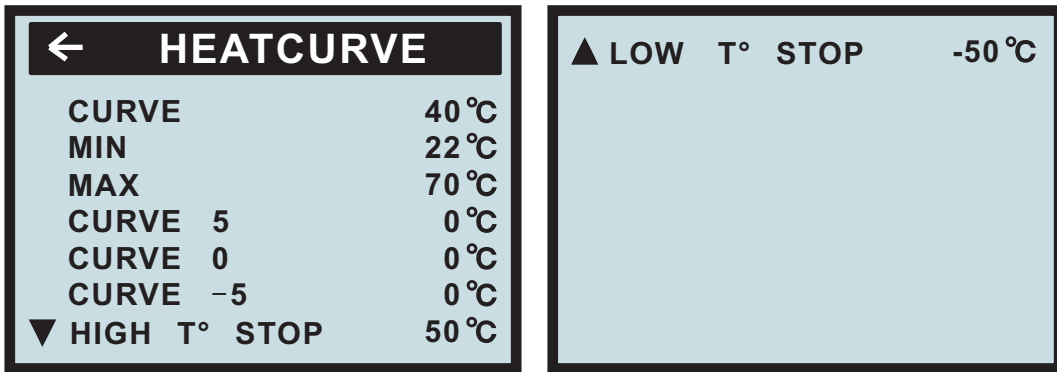

Table 1: Menu- HEAT CURVE

Menu Text	Description	Adjustable by
CURVE	The value entered shows the temperature of the water to be distributed to the radiators (feed water temperature) when the outside air temperature is 0°C.	used(see "Adjustment of CURVE value" on p20.)
MIN	Adjustment of value for lowest feed water temperature allowed.	used(see "Adjustment of MIN & MAX value" on p24.)
MAX	Adjustment of value for highest feed water temperature allowed.	used(see "Adjustment of MIN & MAX value" on p24.)
CURVE 5	Adjustment of room temperature when the outside air temperature is +5°C.	used(see "Adjustment of CURVE value" on p20.)
CURVE 0	Adjustment of room temperature when the outside air temperature is 0°C.	used(see "Adjustment of CURVE value" on p20.)
CURVE - 5	Adjustment of room temperature when the outside air temperature is -5°C.	used(see "Adjustment of CURVE value" on P20.)
HIGH T STOP	When outdoor ambient temperature is higher than this setting, the hot water to room will be stopped.	this setting is adjustable from 0 to 50°C, factory setting is 50°C.
LOW T STOP	When outdoor ambient temperature is lower than this setting, the hot water to room will be stopped.	this setting is adjustable from 0 to -50 °C, factory setting is -50°C.

3.1.2.4 Sub-Menu TEMPERATURE

This menu shows the different temperatures of the heating system. All temperature changes registered over the last 60 minutes are stored in the control system and can be viewed in the shape of graphs.

← TEMPERATURE		
OUT	25	°C
ROOM	28	°C
FEED.	30(65)	°C
RETURN	45	°C
WARMWT	30(50)	°C
PIPE	22	°C

OUT: Display outdoor ambient temperature.

ROOM: Display room air temperature.

FEED:

1.the first value is real feed water temperature, the second value in '()' is feed water setting temperature in ROOMHEAT 1 mode, it is adjusted by slope of Curve according to outdoor ambient temperature. Factory setting is that feed water temperature is 40°C when outdoor ambient temperature is 0°C, that is to say Curve is 40, the value of Curve is adjust from 22°C to 56°C. This setting is only available for Room heating, not for water tank heating.

2. under ROOMHEAT 2 mode, FEED setting can be adjust directly from 20 to 65°C, factory setting is 45°C; this setting is only available for room heating, not for water tank heating.

RETURN: Display return water temperature.

WARMWT: water tank temperature, the first value is water tank real temperature, the second value in '()' is water tank setting temperature; the setting temperature is adjustable from 20 °C to 62°C, factory setting is 45°C.

PIPE: Display outdoor unit evaporator temperature (for defrosting)

When at item WARMWT or RETURN or FEED, or PIPE, press button Right 5 seconds will display the information as follow kind of chart, to check how the temperature is going in one hour.

3.1.2.5 Sub-Menu INTEGRAL

← INTEGRAL 00		
OFF		00
CMP. A	- 60	(00)
ADD 1	- 500	(- 60)
ADD 2	- 550	(- 500)
ADD 3	- 600	(- 550)

Integral (DM) is a program to set the startup time and distance between compressor and electrical heater according to heat demand and heat output, to set stop conditions of compressor and electrical heater. This program is depends on the "feed water temperature degeneratiaon" and Time. To enter this menu operator can change the factory setting:

Menu Text	Description	Adjustable by
OFF	When the value (testing) reaches the value setting by user, the system will be closed.	USER
CMP.A	When the value (testing) reaches the value setting by user, the compressor will be start-up. And the value (testing) under the value (setting), the compressor will be closed.	USER
ADD1	When the value (testing) reaches the value setting by user, the ADD 1 will be start-up. And the value (testing) under the value (setting), the ADD1 will be closed.	USER
ADD2	When the value (testing) reaches the value setting by user, the ADD2will be start-up. And the value (testing) under the value (setting), the ADD2 will be closed.	USER
ADD3	When the value (testing) reaches the value setting by user, the ADD 3 will be start-up. And the value (testing) under the value (setting), the ADD3 will be closed.	USER

Instruction of Integral (DM)

Degree Minute = The corresponding value of temperature difference between the Feed water and the Desired water X Running time (through **integral** to change; every minute for a cumulative)

Temperature difference between the feed water and the desired water (°C)	The corresponding value
-31 ~ -40	-40
-21 ~ -30	-30
-11 ~ -20	-20
-1 ~ -10	-10
1 ~ 10	10
11 ~ 20	20
21 ~ 30	30
31 ~ 40	40

For example:

(Under desired temperature)

Feed water temperature decrease 1°C (under desired temperature) in 1 minutes,

Degree Minute=-10 X 1 = -10;

Feed water temperature continue decrease 2°C(under desired temperature) in another 1 minutes,

Degree Minute=-10 X 1 + (-10) = -20;

Feed water temperature continue decrease 3°C(under desired temperature) in another 1 minutes,

Degree Minute=-10 X 1 + (-20) = -30;

Feed water temperature continue decrease 4°C(under desired temperature) in another 1 minutes,

Degree Minute=-10 X 1 + (-30) = -40;

.....

Before the Degree Minute reach - 60 (adjustable) ,the compressor is off, but when the Degree Minute reach - 60 (adjustable) ,the compressor automatic start, and the flow temperature will begin increase.

(Higher than desired temperature) when the actual water supply temperature reach / higher than the desired temperature, the DM will be changed.

For example : the DM was cumulated to -160 in this time.

1 minutes later when the Feed water temperature higher than desired temperature for 1°C.

10X1=10 , Degree Minute= -150;

Another 1 minutes later when the Feed water temperature higher than desired temperature for 2°C. 10X1=10, Degree Minute= -140;

Another 1 minutes later when the Feed water temperature higher than desired temperature for 3°C. 10X1=10, Degree Minute= -130;

Another 1 minutes later when the Feed water temperature higher than desired temperature for 4°C. 10X1=10, Degree Minute= -120;

.....

Compressor off when Degree Minute reach 0 (adjustable) .

The relationship between compressor (on and off) and DM,the relationship between heater(on and off) and DM.

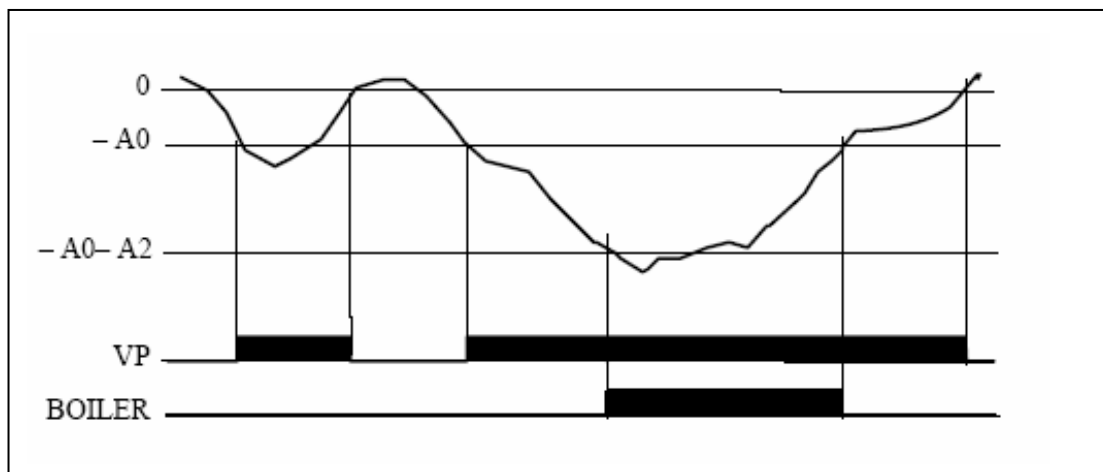

The above chart is describing that running of compressor and electrical heater depend on Integral

Compressor 's Degree Minute are :-60 (on) and 0(off),A0=-60 (on)

Heater 1's Degree Minute are : '-500'(on) and '-60'(off), A0+A2=-60-440=-500 (on)

Heater 2's Degree Minute are : '-500'(on) and '-500'(off)

Heater 3's Degree Minute are : '-600'(on) and '-550'(off)

3.1.2.6 Sub-Menu OPERATING TIME

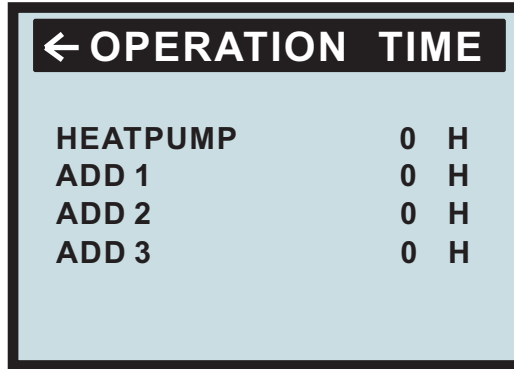

Menu Text	Description	Adjustable by
HEATPUMP	Total operating hours of heat pump since installation. Operating time will not be reset to zero.	can not
ADD1	Total operating hours of auxiliary heater (3kW) since installation. Operating time will not be reset to zero.	can not
ADD2	Total operating hours of auxiliary heater (6kW) since installation. Operating time will not be reset to zero.	can not
ADD3	Total operating hours of auxiliary heater (9kW) since installation. Operating time will not be reset to zero.	can not

3.1.2.7 Sub-Menu RESET

Reset to factory setting value. Press the right button for 5 seconds.

3.1.2.8 Sub-Menu MAN TEST

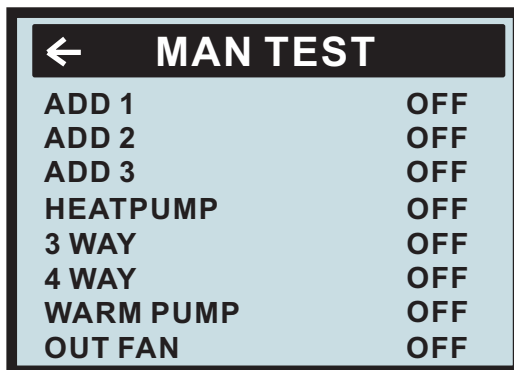

How to enter the Sub-Menu MAN TEST:

You need to choose the "MAN TEST" on the main menu (INFORMATION)

And press the right button for 3 seconds .

The Sub-Menu MAN TEST contains ADD1 / ADD2 / ADD3 / HEAT PUMP / 3 WAY

4 WAY / WARM PUMP / OUT FAN; You can choose ON / OFF to control the each part for testing.

Notice: when installer to test the components function in submenu 'MAN TEST', it recommend that start the water pump before start the compressor and electrical heater.

3.1.2.9 Sub-Menu DEFROST

How to enter the Sub-Menu DEFROST:

You need to choose the "DEFROST" on the main menu (INFORMATION).

Press the right button. Then "DEFROST" menu can be seen.

You can choose "Intell Defrost" or "Manual Defrost"

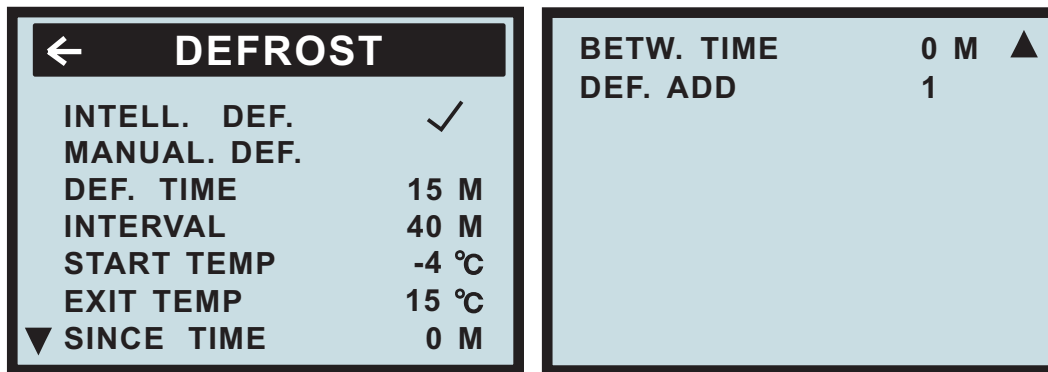

INTELL.DEF:

Intelligent defrost program: after you choose this function, defrost program is intelligent and automatic; when outdoor unit's heat changer (evaporator)'s pipe temperature is less than 3 °C continuously for 40 minutes, and the temperature is less than setting temperature, will start the defrosting.

After defrosting:

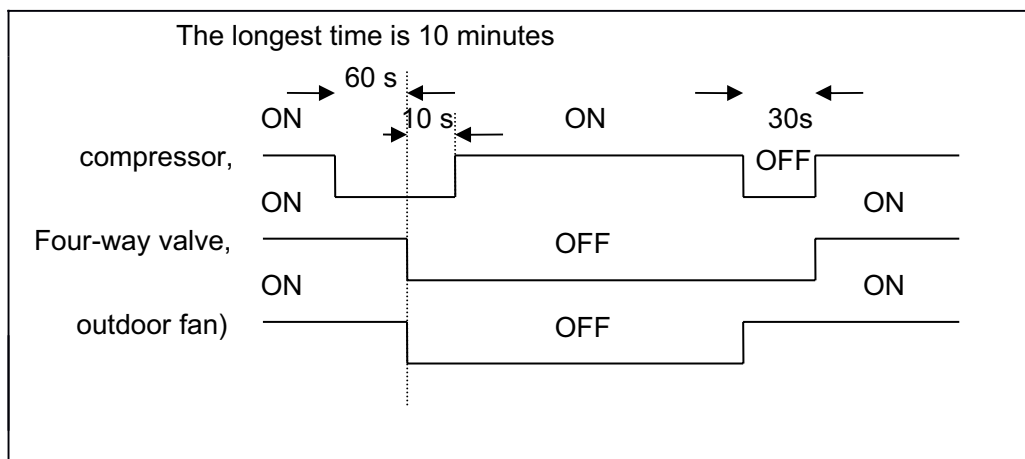

In Intelligent defrost mode, operator can adjust the setting of defrosting according to different ambient temperature and humidity.

Select START TEMP, then press button Right for a long time, to enter the defrosting setting:

Outdoor ambient temperature	Defrost start temperature (pipe at evaporator)	Outdoor ambient temperature	Defrost start temperature (pipe at evaporator)	Outdoor ambient temperature	Defrost start temperature (pipe at evaporator)
2	-3	-7	-11	-16	-20
1	-3	-8	-12	-17	-21
0	-4	-9	-13	-18	-22
-1	-5	-10	-14	-19	-23
-2	-6	-11	-15	-20	-24
-3	-7	-12	-16	-21	-25
-4	-8	-13	-17	-22	-26
-5	-9	-14	-18	-23	-27
-6	-10	-15	-19	-24	-28

When choose Intelligent defrost mode, the Defrost start temperature will be the same as above form when the ambient temperature is lower than 2 degree, all the value of the form is factory setting and they are adjustable from 0 to -30 degree. Press button Right 5 seconds to enter the form, operator can select any defrost start temperature and revise it. For example, after change the defrost start temperature to be -12 degree under ambient temperature is -3 degree, all the defrost temperature which more than -12 degree will change automatically to -12 degree under the kinds of ambient temperature which less than -3 degree.

Outdoor ambient temperature	Defrost start temperature (pipe at evaporator)	Outdoor ambient temperature	Defrost start temperature (pipe at evaporator)	Outdoor ambient temperature	Defrost start temperature (pipe at evaporator)
-3	Change to -12	-6	Change to -12	-9	Remain-13
-4	Change to -12	-7	Change to -12	-10	Remain-14
-5	Change to -12	-8	Remain-12	-11	Remain-15

After confirmation, the factory setting will change to above and be as new default.

MANUAL.DEF:

Manually defrost (adjustable defrost program): This function is semi-automatic. For example, operator can change the value of INTERVAL(the distance between two defrosting) to be 40 min, and the START TEMP(the start temperature of defrosting) to be -4degree, when the defrosting time request and temperature request were meet at the same time, heat pump go to defrost.

Defrost finish: when outdoor evaporator pipe temperature (EXIT TEMP)'s setting is 15 degree or EXIT TIME (defrosting timing), the defrosting will finish as soon as get one of them.

DEF.TIME:

Duration of defrosting, adjustable from 2 to 20min(factory setting is 15min) defrosting duration

INTERVAL:

Interval of defrosting , adjustable from 25 to 70min(factory setting is 40min)

START TEMP:

Start temperature of defrosting(pipe temperature of outdoor evaporator), adjustable from 2 to -30 degree (factory setting is -4 degree)

EXIT TEMP:

Exit temperature of defrosting(pipe temperature of outdoor evaporator), adjustable from 0 to 20degree (factory setting is 15degree)

SINCE TIME:

Start and exit time of defrosting, to indicate whole time of defrosting.

BETW.TIME:

To record the interval between the ending of first defrosting and the beginning of second defrosting.

DEF. ADD:(default is 1)

Electrical heaters optional:

Select 1, only start one piece electrical heater during defrosting.

Select 2, only start two piece electrical heaters during defrosting.

Select 3, start all three piece electrical heaters during defrosting.

Select OFF, none electrical heater will start during defrosting.

3.1.2.10 Sub-Menu SETTING

How to enter the Sub-Menu SETTING:

You need to choose the "SETTING" on the main menu (INFORMATION).

Press the right button. Then "SETTING" menu can be seen.

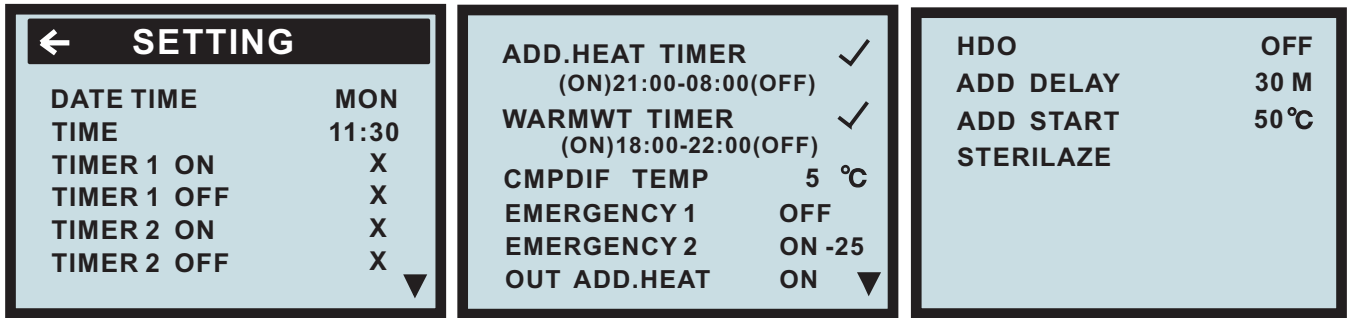

DATE TIME

To display or adjust day of week.

TIME

To display time, or adjust time.

Double timer function:

TIMER1 ON : ✓ 9: 00 **TIMER1 OFF** ✓ 12: 00

TIMER2ON : ✓ 14: 00 **TIMER2 OFF** ✓ 18: 00

TIME ON

When choose mark "✓", the Auto start function is active, choose "x"for cancel this function. If this function is active, every day during the timing, the heat pump will work normally.

TIME OFF

When choose mark "✓", the Auto stop function is active, choose "x"for cancel this function. If this function is active, every day during the timing, the heat pump will stop normally.

ADD.HEAT TIMER ✓ (ON) 21:00-----9:00 (OFF)

When choose mark "✓", the Auto start function of electrical heater is active, choose "x"for cancel this function. If this function is active, every day electrical heater will start and stop automatically according to the setting.

WARMWATER TIMER ✓ (ON) 21:00-----9:00 (OFF)

When choose mark "✓", the Auto start function of water tank heating is active, choose "x"for cancel this function. If this function is active, every day water tank heating will start and stop automatically according to the time setting.

When heat pump is ON, water tank timer function makes sure the water tank heating has priority.

If the heat pump is ON with mode WARMWATER only:

Then if set water tank timer to be: 6:00(ON) ---12:00(OFF), the water tank heating will be available only during clock 6:00 –12:00.

If the heat pump is ON with mode Auto (WARMWATER+ROOMHEAT):

Then if set water tank timer to be: 6:00(ON) ---12:00(OFF), the water tank heating will be available only during clock 6:00 –12:00, the rest time will turn to room heating.

CMPDIF TEMP:

compressor restart determined by water temperature degeneratiao of water tank. This setting is only for water tank heating, it is adjustable from 3 to 15 °C, and factory setting is 5°C.

EMERGENCY1(ONorOFF)

Emergency mode 1 (emergency 1) : (ON or OFF), factory setting is OFF(after select emergency mode, the unit will continuously execute the same objective (room heating only, water tank heating only, or auto)

When select ON, compressor will be switch off, only electrical heater, water pump or other temperature protection are available. When in water tank heating, the electrical heater will instead of compressor; when in room heating mode, the electrical heater will runs depends on Integral; when in room heating mode 1, the electrical heater will runs depends on Integral; when in room heating mode 2, the electrical heater automatically starts, unless operator off the electrical heater.

EMERGENCY2(ONorOFF)

Emergency mode 2 (emergency 2) : (ON or OFF), factory setting is OFF: (after select emergency mode, the unit will continuously execute the same objective (room heating only, water tank heating only, or auto)

When select this mode, compressor will stop determined by outdoor ambient temperature, the temperature setting is from 0 to -50 degree adjustable, factory setting is -25 degree, only electrical heater, water pump or other temperature protection are available. When in water tank heating, the electrical heater will instead of compressor; when in room heating mode, the electrical heater will runs depends on Integral; when in room heating mode 1, the electrical heater will runs depends on Integral; when in room heating mode 2, the electrical heater automatically starts, unless operator off the electrical heater.

OUT ADD.HEATON(OFF)

On sub-menu SETTING, to control outdoor unit electrical heater(bottom electrical heater, evaporator heater), factory setting is ON

Display: OUT ADD.HEAT ON (default)

1. when the outdoor electrical heater is ON, and the compressor is running

A、 the heater will start when heat pump defrost, to speed up defrosting process.

B、 the heater will start when ambient temperature is less than 0 °C , and stop when ambient temperature is more than 4 °C

Display : OUT ADD.HEAT OFF

2 When the outdoor electrical heater be select OFF, the outdoor heater can not start automatically.

HDO ON(OFF)

1 Switch it on the input signal on the wire HDO would block the compressor, fan and additional heater ;

2 Switch it off, the input signal would block nothing.

External signal controls heat pump start and stop: there two signal connections, when external relay switch on them, the compressor, electrical hearer and motor will stop running. After switch off them, the compressor, electrical heater, motor will restart and work as previous setting.

ADD DELAY : (3 to 90 Min adjustable , factory setting is 30M)

ADD START : (45 to 70 degree adjustable , factory setting is 50 degree)

when heating the water tank (after only runs compressor 10 minutes), if two conditions are fulfilled, the electrical heater 1 will start automatically: 1) the current water temperature more than 50 °C (this setting is adjustable from 45 °C to 70 °C); 2) the water temperature can not increase 1 °C in a certain time (from 3 to 90 minutes adjustable, default is 30 minutes); after start electrical heater 1, if the water temperature can not increase 1 °C in a certain time, then electrical heater 2 will start automatically; after start electrical heater 2, if the water temperature can not increase 1 °C in a certain time, the electrical heater 3 will start automatically; then electrical heater work until water get the setting temperature.

STERILIZE:

← STERTLIZE	
WATER TEMP	60 °C
DURATION	10 M
PERIOD	15 D

Sterilize water temperature: (60 °C--90 °C adjustable) default is 60 °C

Sterilize duration : (10—90minutes) default is 10 minutes

Sterilize period : (7---99days) default is 15 days

If the water tank's temperature always less than 60 °C (default) and last 360 hours(period), the heat pump will start the sterilize function (the electrical heater start as soon as water get to 50 °C), until water temperature get to 60 °C(default) and last 10 minutes(default); or if 3 hours later the water temperature still can not reach 60 °C, the sterilize function will exit.

3.1.2.11 Sub-Menu LANGUAGE

Language selection : How to enter the Sub-Menu of LANGUAGE:
You need to choose the "LANGUAGE" on the Main menu (INFORMATION).
Press the right button. Then "LANGUAGE" menu can be seen.

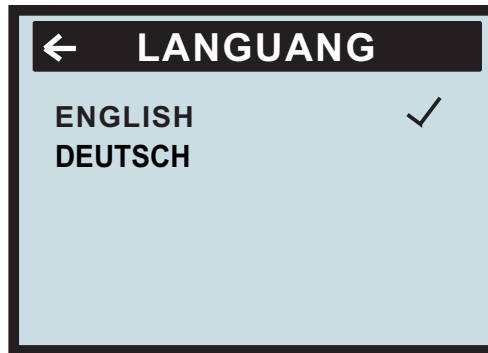

Use Up and Down button to select the language ,and press Right button to confirm.

3.2 Adjustments to be made regularly

Most settings will be made by the installation contractor in connection with installation. Adjustments to be made regularly by the user are the following:

- Selection of operating mode
- Adjustment of desired room temperature by changing the ROOM value.
- Adjustment of heat curve
- Adjustment of maximum and minimum values for feed line temperature
- Adjustment of the value for HIGH T STOP or LOW T STOP is possible. (Please refer to "Adjustment of HIGH T STOP or LOW T STOP value" on p. 25).

3.2.1 Heat Generation - General

The indoor temperature should be adjusted by changing the heat curve of the installation. The control computer determines the correct temperature of the water to be distributed to the heating system based on the heat curve. The heat curve will be adjusted in connection with installation. It must be adapted later on, however, to obtain a pleasant indoor temperature under any weather condition. A correct heat curve reduces maintenance and saves energy.

The heat curve determines the feed line temperature depending on the outside air temperature. The lower the outside air temperature, the higher the feed line temperature. In other words, the temperature of the water feed to the radiators will increase exponentially as the outside air temperature falls.

If you select CURVE in the sub-menu named HEAT CURVE, a diagram will be displayed. It represents the relation of outside air temperature to feed line temperature. This relation is referred to as heat curve.

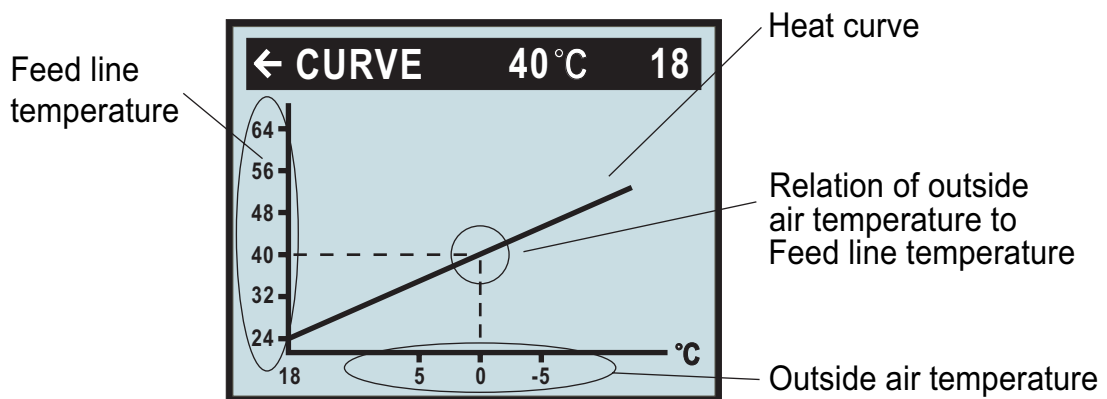

3.2.2 Adjustment of the CURVE value

The heat curve will be adjusted by the CURVE value. This value indicates the feed line temperature to the radiators at 0°C outside temperature. At outside air temperatures lower than 0°C, the water sent to the radiators will be warmer than 40°C.

At outside temperatures higher than 0°C, the water will be colder than 40°C. When you increase the CURVE value, the heat curve will become steeper and when you reduce it, it will become flatter.

This is the most energy and cost efficient way to set the indoor temperature and should therefore be used for long term temperature settings. If you wish to make a temporary change of temperature, you can simply change the ROOM value (see "Adjustment of the ROOM value" on page 21).

CURVE is program that adjusts feed water temperature according outdoor ambient temperature, factory setting is ambient temperature 0°C as feed water temperature 40°C, that is CURVE =40; the value of CURVE is adjustable from 22°C to 56°C.

How to change the slope—two points decide one beeline, point one is (0,40), the other point could be (18,24), the point (18,24) is not changing when changing the slope, because factory setting is that heat pump stops when outdoor ambient temperature is 18°C, so the feed water temperature should be 24°C.

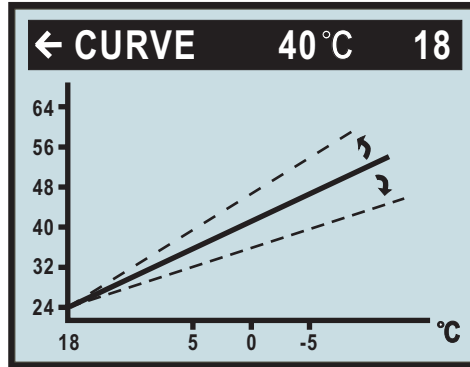

Change of value for CURVE

If you wish to change the CURVE value:

1. Open the main menu INFORMATION by pressing the right-hand button once. You will find the cursor at the sub-menu named OPERATION
2. Press the "down" button to move the cursor to the sub-menu called HEAT CURVE.
3. Press the right-hand button once to open the menu. You will find the cursor at the parameter CURVE
4. Open the selected parameter by pressing the right-hand button once.
5. Increase or reduce the preset value using the "up" or "down" button. You will see from the diagram how the gradient of CURVE changes.

Press the left-hand button three times to return to the main menu.

3.2.3 Adjustment of ROOM value

As mentioned above, you can also adjust heat curve and indoor temperature by changing the ROOM value. If you use ROOM value to adjust the heat curve, the gradient does not change, i.e. it doesn't become steeper or flatter. Instead, the whole curve is moved by 1°C for every degree by which the ROOM value is changed.

The relation feed line temperature to outside air temperature will not be affected. The feed line temperature will be increased or reduced by the same number of degrees all along the heat curve. See the following diagram.

Adjustment of the ROOM value should only be used for temporary changes of the indoor temperature. For long term settings, the CURVE value should be adjusted as this is the most energy and cost efficient way to set the indoor temperature.

For adjusting the heat curve, please refer to the chapter "Adjustment of the CURVE value" on page 20.

You need to choose the "room" on the Sub-menu (TEMPERATURE), then press the right button.

Use UP and DOWN button to adjust the "ROOM CURVE" Factory setting of ROOM value is 20°C.

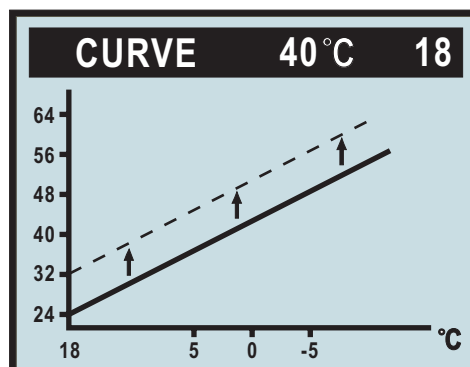

Change of the ROOM value

If you wish to change the ROOM value:

- 1 Press the "up" or "down" button once to open the ROOM value for adjustment.
- 2 Increase or reduce the preset value using the "up" or "down" button so that the desired room temperature is reached. Wait for 10 seconds or press the left-hand button once to return to the main menu.

When enter 'Room heat' mode, user could control compressor and electrical heater through regulate heat curve or DM (degree minute).

under a certain ambient temperature ,the time start of compressor is determined by degree minute(DM).

Now we are giving two situations to explain.

1. 'start quickly' is determined by FEED(heat curve)

Suppose now the feed water temperature is 25°C; regulate the heat curve to let the setting of water temperature to be a higher value such as 55°C, that is FEED25(55). At that time, DM (degree minute) decrease -30 per minute, when the DM reach -60, compressor will start right away.

(Notice: if the water temperature setting is lower than feed water temperature DM would turn to positive number, and then compressor does not start. Of course, you also can regulate the DM to be near the value for compressor start, such as -20.

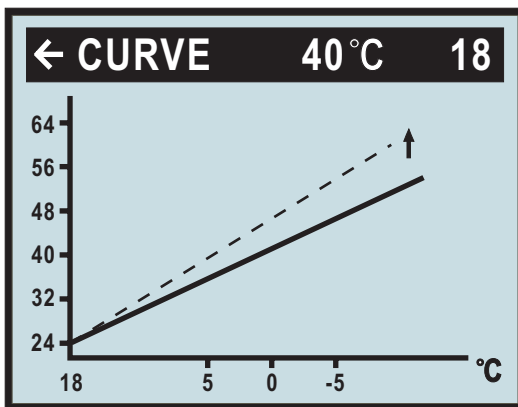

turn it up

2. 'start slowly' is determined by FEED(heat curve)

Suppose now the feed water temperature is 25°C, if regulate the heat curve to let the setting of water temperature to be a lower value such as 30°C, that is FEED25(30); at that time, the DM would decrease -10 per minute, the time to reach -60 is becoming longer, only after some time, then compressor can start. You also can regulate the DM to be more far away from the value for compressor start, such as (-100).

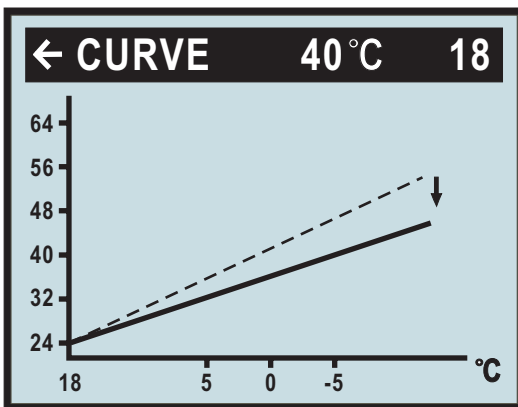

curve is a little flat

When enter room heat mode, it needs customer to regulate the heat curve or DM (degree minute) according to own request.

3.2.4 Adjustment of Part of the Heat Curve

At outdoor temperatures between -5°C and $+5^{\circ}\text{C}$ part of the heat curve may need adjusting if the indoor temperature does not stay at the preset ROOM value. For this reason, the control system includes a function adjusting the curve at three outside temperatures: -5°C , 0°C , $+5^{\circ}\text{C}$. This function will allow you to increase or reduce the feed line temperature, without affecting the heat curve, at three specific outdoor temperatures. If, for example, the outside temperature is -5°C , the feed line temperature will change gradually in the outdoor temperature range of 0°C to -10°C , maximum adjustment being reached at -5°C . The diagram below shows an adjusted CURVE -5 . The point of maximum adjustment is clearly visible.

As we have seen, you can choose to adjust the heat curve at three specified outside air temperatures: -5°C , 0°C and $+5^{\circ}\text{C}$. The feed line temperature can be changed by plus/minus 3 degrees.

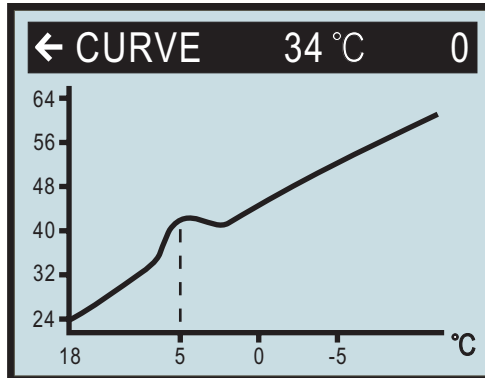

When outdoor ambient temperature is 5°C , this setting is available to change the feed water temperature, it is adjustable by operator: heat curve is not change (the slope is no change), but the point near 5°C (from 0°C to 10°C), curve can be change step by step; the variable is the biggest at 5°C , it is $\pm 3^{\circ}\text{C}$

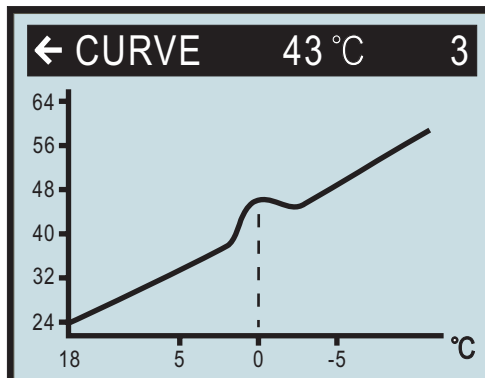

When outdoor ambient temperature is 0°C , this setting is available to change the feed water temperature, it is adjustable by operator: heat curve is not change (the slope is not change), but the point near 0°C (from -5°C to $+5^{\circ}\text{C}$), curve can be change step by step; the variable is the biggest at 0°C , it is $\pm 3^{\circ}\text{C}$.

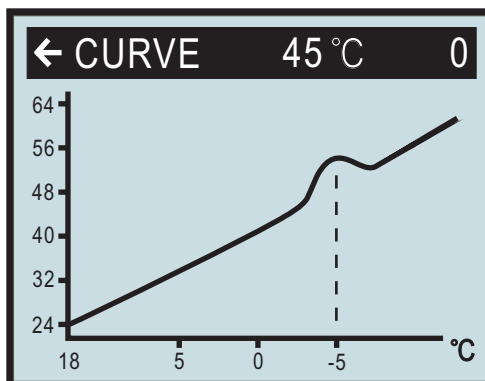

When outdoor ambient temperature is -5°C , this setting is available to change the feed water temperature, it is adjustable by operator: heat curve is not change (the slope is not change), but the point near -5°C (from 0°C to -10°C), curve can be change step by step; the variable is the biggest at 0°C , it is $\pm 3^{\circ}\text{C}$.

If you wish to change a specific part of the heat curve:

1. Open the main menu INFORMATION by pressing the right-hand button once. You will find the cursor at the sub- menu OPERATION.
2. Press the "down" button to move the cursor to the sub-menu HEAT CURVE.
3. Open the selected menu by pressing the right-hand button once. You will find the cursor at the parameter CURVE.
4. Using the "up" or "down" button, select either CURVE 5, CURVE 0 or CURVE -5.
5. Open the selected curve by pressing the right-hand button once.
6. Raise or lower the value, using respectively the "up" or "down" button. To return to the main menu, press the left- hand button three times.

3.2.5 Adjustment of the MIN and MAX value

The MIN and MAX value is the lowest respectively highest value that is allowed for the supply line temperature. Adjusting the minimum and maximum supply line temperature is particularly important if your home has floor heating. If your house has floor heating and parquet floor, the supply line temperature should not be higher than 45°C. Else the floor might get damaged. If you have floor coils and stone tiles, the MIN value should be 22-25°C in summer when no heating is required to obtain a comfortable floor temperature.

MIN

MIN is the minimum setting of feed water temperature; it is adjustable by operator from 10 to 30 °C, factory setting is 22°C; if the room's floor use ceramic tile, then the setting of MIN can not less than 22°C (this value can get a comfortable floor temperature); the heat pump will restart as soon as actual feed water temperature less than MIN setting.

MAX

MAX is the maximum setting of feed water temperature, it is adjustable by operator from 30 to 70°C, and factory setting is 70°C; if heat pump is using for floor heating, this setting is very important, because at the time the feed water temperature can not higher than 70°C, otherwise could be dangerous; the heat pump will stop as soon as actual feed water temperature more than MAX setting.

If there is a basement to your house, the MIN value should be adjusted to a suitable temperature in summer too, to avoid a humid and chilly basement. In such cases, the value for HEAT STOP needs being adjusted upwards. If you wish to change the MIN or MAX value:

1. Open the main menu INFORMATION by pressing the right- or left-hand button once. You will find the cursor at the sub-menu OPERATION
2. Press the "down" button to move the cursor to the sub-menu HEAT CURVE
3. Open the selected menu by pressing the right-hand button once. You will find the cursor at the parameter CURVE.
4. Press the "down" button to move the cursor to MIN.
5. Open the selected parameter by pressing the right-hand button once. The cursor is at MIN
6. Raise or lower the value, using the "up" and "down" button respectively.
7. Press the left-hand button three times to return to the main menu.

Repeat the procedure to change the MAX value, replacing MIN by MAX at step 4.

3.2.6 Adjustment of the HIGH T STOP and LOW T STOP

'HIGH T STOP' and 'LOW T STOP' functions are only for room heating, the water tank heating still works normally when the two functions are active.

The HIGH T STOP and LOW T STOP function stops water production to room floor when the outside air temperature is equal to higher or lower than the value entered for HIGH T STOP or LOW T STOP. When the function is activated, the circulation pump will be turned off. The factory setting of the HIGH T STOP is 50°C.(0 -50 °C adjustable) The factory setting of the LOW T STOP is -50°C.(-50 -0 °C adjustable) .

If you wish to change the HIGH T STOP OR LOW T STOP value:

- 1 Open the main menu INFORMATION by pressing the right- or left-hand button once.
You will find the cursor at the sub-menu OPERATION
- 2 Press the "down" button to move the cursor to the sub-menu HEAT CURVE
- 3 Open the selected menu by pressing the right-hand button once.
- 4 You will find the cursor at the parameter CURVE.
- 5 Press the "down" button to move the cursor to HIGH T STOP or LOW T STOP.
- 6 Open the selected parameter by pressing the right-hand button once. The cursor moves to HIGH T STOP or LOW T STOP.
- 7 Raise or lower the value, using respectively the "up" or "down" button.
- 8 Press the left-hand button three times to return to the main menu.

3.2.7 Graph of recent changes in TEMPERATURE

All temperatures registered during the last hour can be viewed in the sub-menu TEMPERATURE in the shape of a graph. This will enable you to monitor changes in the different system temperatures.

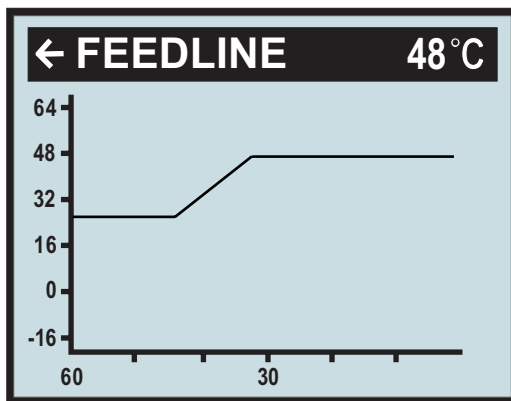

There is a graph available for all temperatures, except for the OUT / ROOM temperature, where you can only view the measured value. The integral value that is displayed represents the heating system's energy balance.

If you wish to check the TEMPERATURE graphs:

- 1 Open the main menu INFORMATION by pressing the right- or left-hand button once.
You will find the cursor at the sub-menu OPERATION.
- 2 Press the "down" button to move the cursor to the sub-menu TEMPERATURE
- 3 Open the menu by pressing the right-hand button once.
- 4 You will find the cursor at the parameter OUT.
- 5 Press the "down" or "up" button to move the cursor to the desired temperature.
- 6 Open the selected value by pressing the right-hand button once. A graph will be shown in the display.
- 7 Move the cursor along the time axis using the "up" (plus) or the "down" (minus) button.
The exact temperature at the selected point of time appears at the top of the display.
- 8 Press the left-hand button three times to return to the main menu.

3.3 Maximum Return Line Temperature

The maximum return line temperature, i.e. temperature of the water returning from the heating system, should be adapted to each individual installation. The correct temperature value for your system will be entered by your installation contractor in connection with installation and can be adjusted later.

3.4 Warm Water Production

The temperature of the water distributed to the water heater is controlled by the regulating pressure switch and cannot be adjusted.

Reading of warm water temperature.

To check the actual warm water temperature on the display:

- 1 Open the main menu INFORMATION by pressing the right- or left-hand button once. You will find the cursor at the sub-menu OPERATION.
- 2 Press the "down" button to move the cursor to the sub-menu called TEMPERATURE.
- 3 Open the menu by pressing the right-hand button once.
- 4 Press the "down" button to move the cursor to the parameter WARMWATER.
- 5 Open the selected parameter by pressing the right-hand button for 3 seconds.

A graph will be shown of last hour's warm water temperatures.

- 6 Press the left-hand button three times to return to the main menu.

The value displayed next to the parameter WARMWATER is the actual hot water temperature. The value in brackets is the temperature at which warm water production will start. When the actual temperature falls below that value, warm water production starts. The starting value is not adjustable.

3.5 Regular Checks

3.5.1 Check of Operating Mode

In the event of an alarm, The background light of LCD will flash and an alarm message will be displayed.

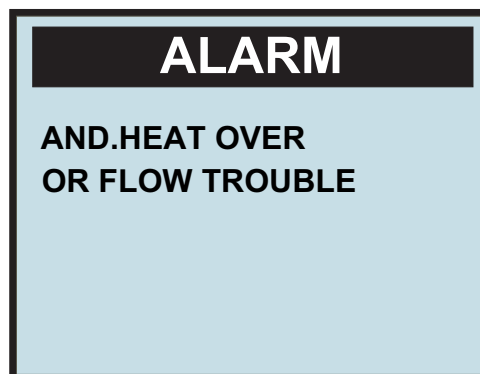

Check the alarm indicator regularly to make sure that the heat pump works properly. You would not always notice if there is something wrong, as the auxiliary heater would start automatically (provided, of course, operating mode AUTO was selected). For more information, please refer to the chapter TROUBLE SHOOTING on p. 28.

3.5.2 Checking the Water Level of the Heating System

The pressure of the heating system should be checked once monthly. The pressure, shown on the external pressure gauge, should be 1-1,5 bar. If the value is below 0.8 bar with cold water in the heating system, more water must be added (applies to a closed expansion vessel). To find out where the pressure gauge is located.

You can use ordinary tap water for filling the heating system. In some rare cases the water quality would be unsuitable for this purpose (corrosive or calcareous water). In case of doubt, we would recommend that you call your installation contractor.



Don't use any water treatment additives for the heating system!

3.5.3 Checking the Safety Valves

Both safety valves of the heating system should be checked at least four times a year to prevent lime deposits to clog the mechanism. To find out where the safety valves are located.

The safety valve of the water heater protects the closed heater against positive pressure. It is fitted on the cold water inlet line, its outlet opening facing down-wards. If the safety valve is not checked regularly, the water heater might be damaged. It is quite normal that the safety valve lets out small amounts of water when the water heater is being charged, especially if a lot of warm water was used previously.

To check the safety valves, give the cap a quarter of a turn clockwise until the valve lets out some water through the overflow pipe.

If a safety valve does not work properly, it must be replaced. Check with your installation contractor. See "References" on page 30.

The opening pressure of the safety valve is not adjustable.

3.5.4 In the Event of Leakage

In the event of leakage in the warm water lines between unit and water taps, the shut-off valve on the cold water inlet line should be closed immediately.

Call your installation contractor (see "References" on page 30). In the event of leakage in the sytem circuit, turn off the heat pump and call your installation contractor immediately. See "References" on page 30.

4 Trouble shooting

4.1 Alarm Messages

In the event of an alarm message, try to re-start the unit with the safety switch.

If this does not work, try to solve the problem with the help of the table below. Call your installation contractor if you need help. See "References" on page 30.

Table 3: Alarm Messages

Error code	Explanation	Cause	How to do
RETURN TEMP	Return water temperature sensor error;	Sensor disconnected; Sensor was defective.	Check the connections, the wire of sensor, or change the sensor. Under 25 °C, the resistance of sensor should be 5K
FEEDLINE TEMP	Supply water temperature sensor error;	Sensor disconnected; Sensor was defective.	Check the connections, the wire of sensor, or change the sensor. Under 25 °C, the resistance of sensor should be 5K
PIPE TEMP	Defrost temperature sensor (on evaporator) error	Sensor disconnected; Sensor was defective.	Check the connections, the wire of sensor, or change the sensor. Under 25 °C, the resistance of sensor should be 5K
OUTDOOR TEMP	Outside air temperature sensor error	Sensor disconnected; Sensor was defective.	Check the connections, the wire of sensor, or change the sensor. Under 25 °C, the resistance of sensor should be 5K
ROOM TEMP	Room air temperature sensor error;	Sensor disconnected; Sensor was defective.	Check the connections, the wire of sensor, or change the sensor. Under 25 °C, the resistance of sensor should be 5K
CMP TEMP	Compressor exhaust temperature sensor error;	Sensor disconnected; Sensor was defective.	Check the connections, the wire of sensor, or change the sensor. Under 25 °C, the resistance of sensor should be 50K
WARM WATER TEMP	Water tank temperature sensor error	Sensor disconnected; Sensor was defective.	Check the connections, the wire of sensor, or change the sensor. Under 25 °C, the resistance of sensor should be 5K
HIGH PRESS (single compressor system)	Compressor high pressure protection	The wire disconnected; lack of refrigerant; water flow stop in the room cycle	Check the wire connection; check refrigerant quantity; Check the water cycled pump for the room heating system; Check if the water system contains air
COMP.A PRESS(double compressor system)			
LOW PRESS (single compressor system)	Compressor low pressure protection	The wire disconnected; lack of refrigerant;	Check the wire connection; check refrigerant quantity;
COMP.B PRESS(double compressor system)			
CMP OVER	Compressor overload	The actual current over the contactor's allowed current. Compressor current too large;	Check the wire connection; Check if the water system contains air, and cause the water temperature over high and current over large
ADD HEAT OVER OR FLOW TROUBLE	Supplementary electrical heater over heat or water flow got problem	The temperature of electrical heater over the max allowed temperature. Water flow too small or stopped.	Check the wire connection; Check if the water system contains air or without water
CMP AIR OVER	Compressor exhaust air temperature over heat	Water flow too small; Lack of refrigerant	Check if the water system contains air or without water Check the refrigerant quantity
WARMWATER TEMP TOO LOW	Temperature of the water tank is too low.	Water tank temperature less than 10 °C	A . During heat pump running, whatever mode heat pump runs, heat pump will give an alarm with sound, at the time, heat pump will automatically turn to water tank heating, and then go back to previous running mode until water tank's temperature get to 20°C B . During heat pump is not running, heat pump will give an alarm with sound: WARM WATER. TOO LOW
POWER SUPPLY	Phase error	For three-phase, the phase order reversed or wrongly connected. For single-phase, the " three-phase option Port" in the circuit board is not connected or loose.	Please check if the phase connections were correct.

5 Terminology and Abbreviations

Evaporate	In the evaporator, energy from the heat source is absorbed by the refrigerant passing through the evaporator. The refrigerant turns into gas. (See "Heat Pump Principle" on p. 4).
INTEGRAL	INTEGRAL is the heat balance of the heating system. Production of heat is regulated acc. to a calculated heat demand value. This value is determined by comparing the actual supply line temperature with its calculated (setpoint) value. The difference between the two values is multiplied by the time during which the difference is active. The resulting value is referred to as the integral. The integral value is automatically established when heat is being produced. The value can be viewed in the sub-menu TEMPERATURE.
Compressor	The compressor raises temperature and pressure of the the refrigerant (See "Heat Pump Principle" on p.4).
Condenser	In the condenser, the refrigerant releases its heat energy to the heating circuit. (See "Heat Pump Principle" on p.4)
CURVE	The CURVE value will be adjusted on the control panel. The value indicates the temperature of the water distributed to the radiators (supply line temperautre) at an outside air temperature of 0°C.
Refrigerant	Circuit in the heat pump filled with refrigerant that by evaporation, compression, and circuit condensation absorbs heat energy from the sytem circuit and releases it to the Heating circuit.
Radiator	Heating element
Control	The control computer regulates the whole installation. All system settings and computer temperature changes are stored and registered in the computer. Settings are adjusted iav the graphic display on the control panel.
Heating circuit	The heating circuit receives heat energy from the refrigerant circuit and carries it to the water heater or radiator/ floor coil systems. (See further"Heat Pump Principle" on p.4).
Heat curve	The heat curve is the control computer's instrument for determining the required supply line temperature of the heating system. Indoor temperature will be adjusted by adjustment of the CURVE value

6 Default Settings

The first column of table 7 shows the parameters that are adjustable by the User. The second column shows settings made at the factory and the third column the settings made by the installation contractor in connection with installation of the heat pump.

Make sure that the installation contractor enters any settings made during installation that are particular for your heat pump. This will make it easier for you when you make your own adjustments.

Table 7: Default Settings

Parameter	Factory setting	Individual settings by installation contractor
ROOM	20°C	
OPERATION	AUTO	
CURVE	40°C	
MIN	22°C	
MAX	70°C	
CURVE 5	0°C	
CURVE 0	0°C	
CURVE -5	0°C	
HIGH T STOP	50°C	
LOW T STOP	-50°C	

7 References

Installation and commissioning by:

Piping installation	
Date:	
Company:	
Name:	
Phone:	

Electric installation	
Date:	
Company:	
Name:	
Phone:	

System Adjustment	
Date:	
Company:	
Name:	
Phone:	

If these instructions are not followed during installation, operation, and maintenance, the obligations of our company under the warranty regulations are no longer binding.

Our company reserves the right to alter any details and specifications without prior notice.

